

## Main

Range of product	Telemecanique Photoelectric sensors XU
Series name	General purpose single mode
Electronic sensor type	Photo-electric sensor
Sensor name	XUM
Sensor design	Miniature
Detection system	Polarised reflex
Material	Plastic
Type of output signal	Discrete
Supply circuit type	DC
Wiring technique	3-wire
Discrete output type	PNP
Discrete output function	1 NO or 1 NC programmable
Electrical connection	1 male connector M8, 4 pins
Product specific application	-
Emission	Red polarised reflex
[Sn] nominal sensing distance	5 m polarised reflex need reflector XUZC50

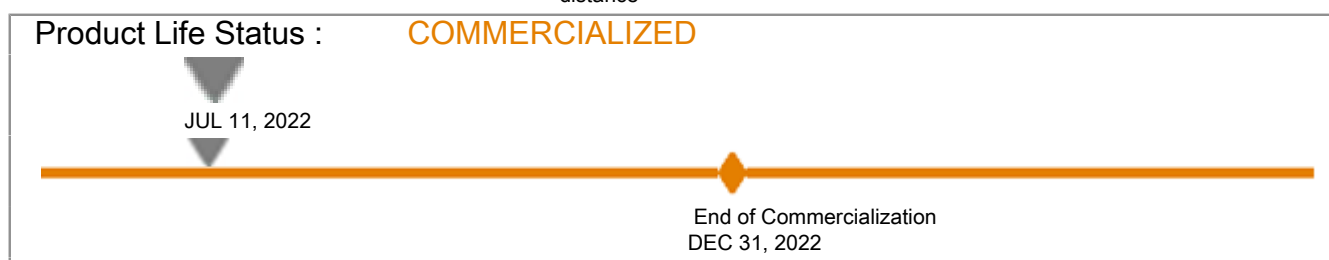

## Complementary

Enclosure material	PBT
Lens material	PMMA
Output type	Solid state
Wire insulation material	PVC
Status LED	1 LED (green) for instability 1 LED (orange) for output state
[Us] rated supply voltage	12...24 V DC with reverse polarity protection
Supply voltage limits	10...30 V DC
Switching capacity in mA	<= 100 mA (overload and short-circuit protection)
Switching frequency	<= 1000 Hz
Maximum voltage drop	<2 V (closed state)
Current consumption	<= 10 mA no-load
Maximum delay first up	100 ms
Maximum delay response	1 ms

Maximum delay recovery	0.5 ms
Setting-up	Sensitivity adjustment by potentiometer
Depth	20 mm
Height	33 mm
Length	11 mm
Width	11 mm
Net weight	0.02 kg



## Environment

Product certifications	CURus CE
Ambient air temperature for operation	-25...55 °C
Ambient air temperature for storage	-30...70 °C
Immunity to ambient light	3000 Lux natural light 3000 lux incandescent light
Vibration resistance	20 gn, amplitude = +/- 1.5 mm (f = 10...500 Hz) conforming to IEC 60068-2-6
Shock resistance	50 gn (duration = 11 ms) conforming to IEC 60068-2-27
IP degree of protection	IP67 conforming to IEC 60529

## Packing Units

Unit Type of Package 1	PCE
Number of Units in Package 1	1
Package 1 Weight	12.0 g
Package 1 Height	1.5 cm
Package 1 width	7 cm
Package 1 Length	13 cm

## Offer Sustainability

REACH Regulation	 <a href="#">REACH Declaration</a>
EU RoHS Directive	Pro-active compliance (Product out of EU RoHS legal scope)  <a href="#">EU RoHS Declaration</a>
Mercury free	Yes
RoHS exemption information	 Yes
California proposition 65	WARNING: This product can expose you to chemicals including: Diisononyl phthalate (DINP), which is known to the State of California to cause cancer, and Di-isodecyl phthalate (DIDP), which is known to the State of California to cause birth defects or other reproductive harm. For more information go to <a href="http://www.P65Warnings.ca.gov">www.P65Warnings.ca.gov</a>

## Contractual warranty

Warranty	18 months
----------	-----------

## Dimensions

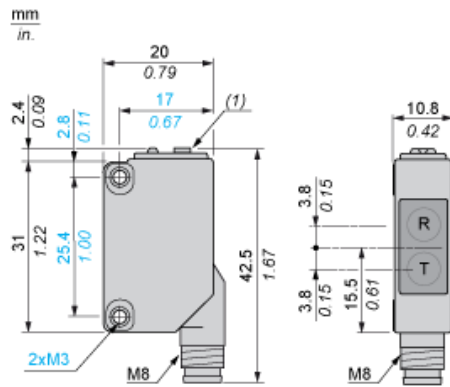

- R : Reception
- T : Transmission
- (1) Potentiometer

## Mounting and Clearance

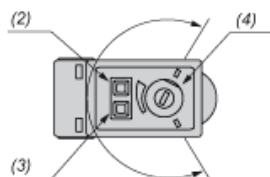
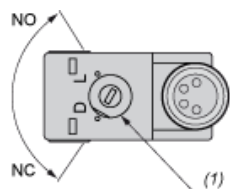

- (1) Configuration switch
- (2) Output state LED
- (3) Stability and power on LED
- (4) Adjustment potentiometer

---

## Connections and Schemes

---

### M8 Connector

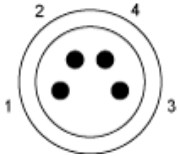

- 1 : (+)
- 3 : (-)
- 4 : OUT/Output

### PNP

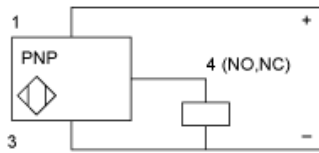

## Detection Curves

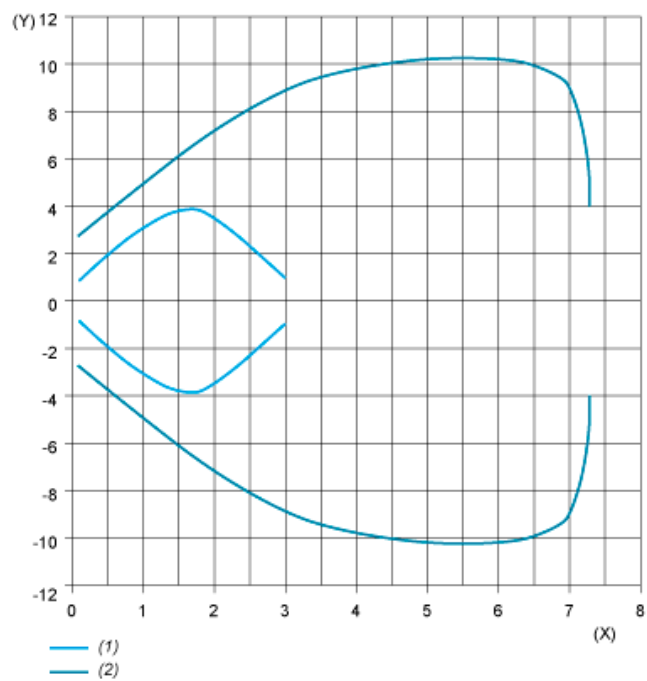

- (1) XUZY08
- (2) XUZY50
- (Y) Parallel movement (cm)
- (X) Distance (m)